

CUSTOMER COPY

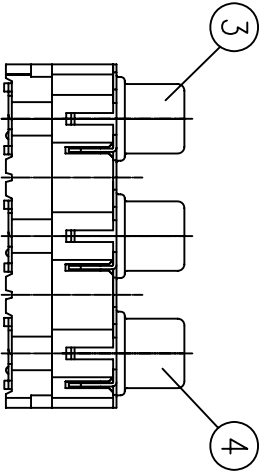

ORDER INFORMATION

1807 1 XX XX X

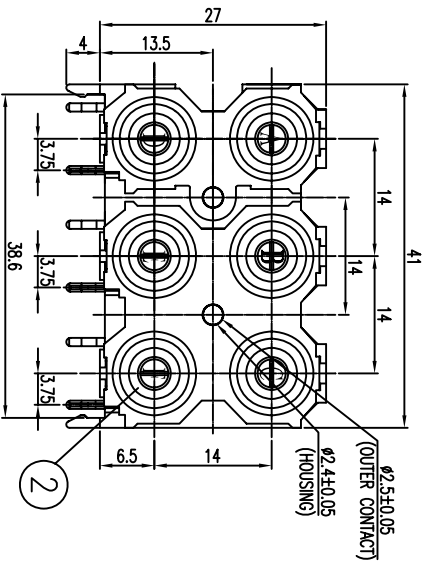
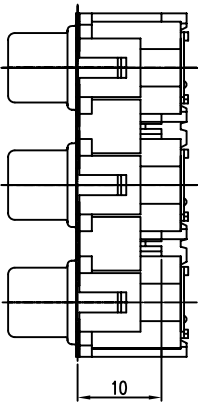
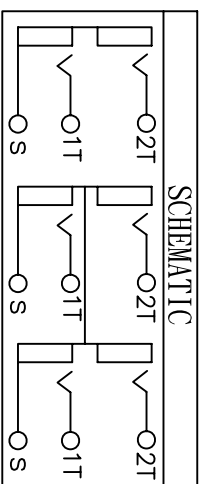
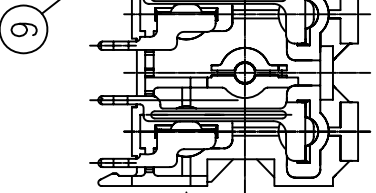
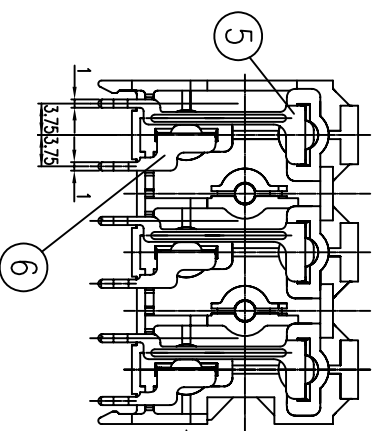
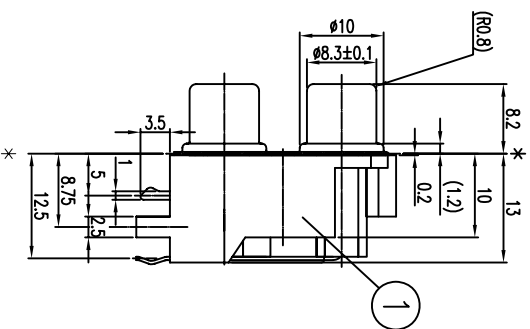
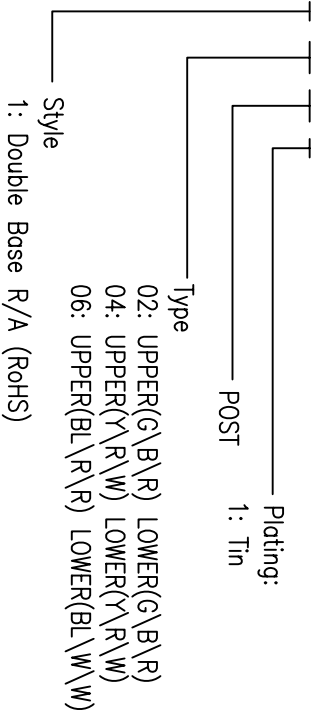

REV	ECN NO.	APP.	DATE
A	NEW DESIGN		

T:1.6 Dimensions of PC board holes
Tolerance : ± 0.1 (Printed-bottom view)

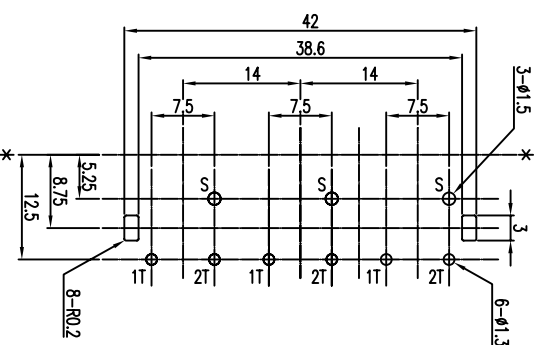

COLOR TYPE					
A	B	C	D	E	F
綠	藍	紅	綠	藍	紅
02	黃	紅	白	紅	白
04	紅	白	黃	紅	白
06	黑	紅	黑	白	白

6	TERMINAL	3	C2680	t=0.5	MB:Cu	Sn/Pb	PLATED
5	TERMINAL	3	C2680	t=0.5	MB:Cu	Sn/Pb	PLATED
4	OUTER CONTACT	1	C2680	t=0.4	MB:Cu	Ni	PLATED
3	OUTER CONTACT	1	C2680	t=0.4	MB:Cu	Ni	PLATED
2	WASHER	3	ABS		UL-94HB		
1	HOUSING	1	ABS		UL-94HB		
LTR	PART NAME	QTY	MATERIAL	REMARK			

ACMELUX CO., LTD.
TEL:886-85124595 FAX:886-85124322

TITLE: RCA JACK DOUBLE BASE
SCALE: 0.01
0.00± 0.30 UNIT: mm
0.000±

MATL: RoHS
CHK BY:
DR BY: JC

